

**Indian Institute of Technology, Kanpur
G.T. Road, Kalyanpur, Kanpur – 208016
Uttar Pradesh, India**



**Notice Inviting Tender
Single Tender Enquiry**

Tender Details

Tender Reference Number	IITK/AE/2024-2025/TDM/01
Item Description	Test Setup for Traction Drive (Integrated test rig for variable speed traction drive)
Item Quantity	01 (One)
Bid Submission Start Date & Time	08.06.2024 & 9:00 AM
Bid Submission End Date & Time	18.06.2024 & 4:30 PM
Bid Opening Date	18.06.2024 at 5:00 PM
Bid Submission Address	Attn: Tanmay Dutt Mathur Dept. of Aerospace Engineering, IIT Kanpur, Kanpur, UP-208016

Sealed quotations are invited for the purchase of the above items in the Two bid system. Both Technical bid and financial bid in separate envelopes must be kept in a big envelope which must be superscribed by Tender Reference number, Item Description and bid submission end date. The sealed copy of bids must reach the above designated address on or before the Bid Submission End Date & Time.



Technical Specifications:

1. The test rig components and assembly are identified in Figure 1 below. The supplier shall provide all components, interfacing hardware, and assembly except the test article, and the cooling fan.

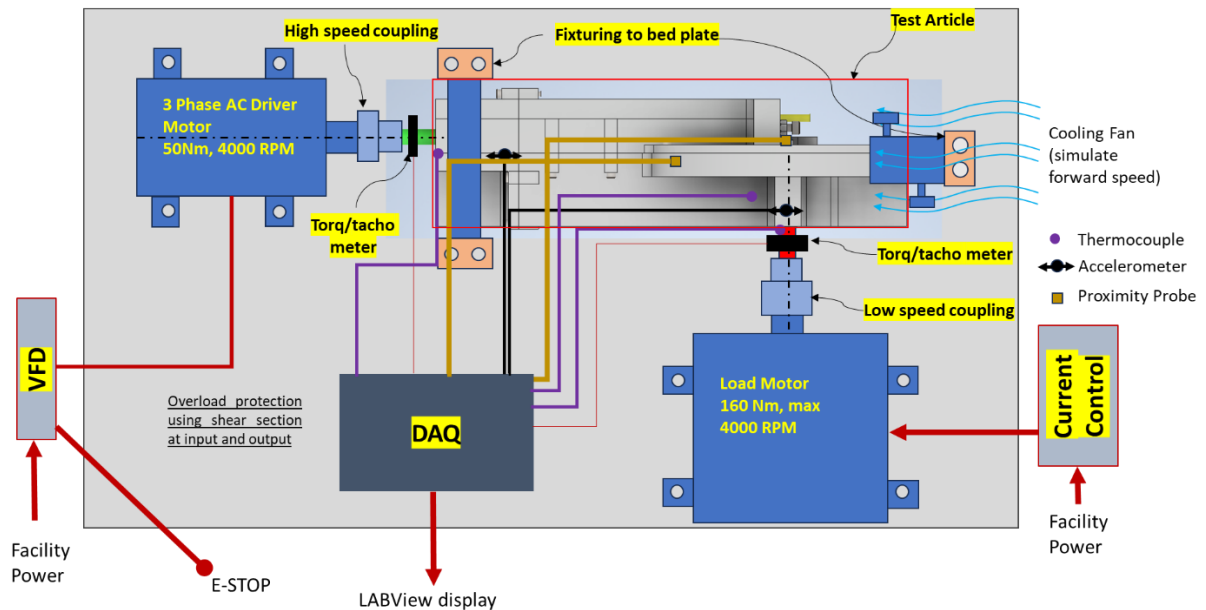

Figure 1: Test rig for traction drive prototype

2. Input side torque meter and tachometer: Up to 4000 RPM, with sampling rate of 128hz - 256hz, 75Nm peak torque, 50 Nm max continuous.
3. The input side driver motor must provide peak input torque of 50 Nm at 3000 RPM. Variable frequency drive for this motor is required.
4. Dynamometer or load motor should provide torque load (up to 160 Nm) at the output side at 1000 RPM. The plots in Figure 2 show the points on the torque speed curve of the motors that must be attained.

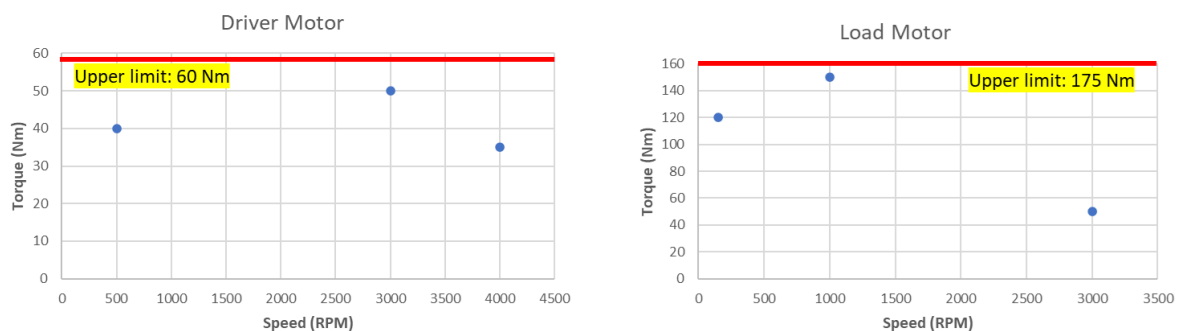

Figure 2: Critical points on the torque-speed graph of motors

5. Output side torque meter and tachometer: Up to 4000 RPM, with sampling rate of 128 hz or higher, 175Nm peak torque, and 150Nm max continuous.
6. Data logger for speed and torque on both sides.

Indenter: Dr. Tanmay Dutt Mathur
Department: Aerospace Engineering
IIT Kanpur-208016

Terms & Conditions:

1. All equipment must be compatible with Indian electrical standards and codes.
2. Ensure to specify make & model of offered product and provide the compliance sheet.
3. Manufacturer Authorization Form from OEM Required.
4. The warranty for the product must be clearly specified.
5. Validity of quotation must be clearly specified.
6. The delivery period must be clearly mentioned.
7. Price should be **F.O.R IIT Kanpur**.
8. **Bidders are advised to upload copies of the previous supply of offered items for price reasonability.**
9. The Institute reserves the right to cancel the tender at any stage without assigning any reason thereof.
10. **This tender is under PAC terms and conditions. Only OEM/Authorized bidders are eligible to participate.**



➤ **Selection Criteria:**

Phase-I: Technical Evaluation & Sample Approval

Technical evaluation will be done based on information/item or product catalogue provided in technical bids submitted by the bidders. A bid containing partial, incomplete, unclear, superfluous and unwanted information will be summarily rejected.

Technical declaration must be supported with relevant documents. Discrepancy in relevant supporting documents and technical compliance sheets shall lead to rejection of technical bids.

Phase-II

- a. Financial bids for technically qualified or/and approved samples shall be opened.
- b. Financial evaluation is purely done on the total financial implication.
- c. Financial Bids with any superfluous, unreasonable rates will be summarily rejected.

➤ **Late Delivery:**

Delivery must be completed within the period mentioned in tender document from the date of receipt of the order. Penalty @ 1% per week or part thereof subject to a maximum of 10% of the delivery price will be deducted from the balance payment if supply is not completed within stipulated period.

➤ **Instruction to the bidder of countries which share land border with India (Rule 144(xi) of GFRs, 2017)**

- I. Any bidder from a country which shares a land border with India will be eligible to bid in this tender only if the bidder is registered with the Department for Promotion of Industry and Internal Trade (DPIIT). Further, any bidder (including bidder from India) having specified Transfer of Technology (ToT) arrangement with any entity from a country which shares a land border with India, shall also require to be registered with the DPIIT.
- II. "Bidder" (including the term 'tenderer', 'consultant' or 'service provider' in certain contexts) means any person or firm or company, including any member of a consortium or joint venture (that is an association of several persons, or firms or companies), every artificial juridical person not falling in any of the descriptions of bidders stated hereinbefore, including any agency branch or office controlled by such person, participating in a procurement process.
- III. "Bidder (or entity) from a country which shares a land border with India" for the purpose of this Order means: -
 - a. An entity incorporated, established, or registered in such a country; or
 - b. A subsidiary of an entity incorporated, established, or registered in such a country; or

Page 5 of 19

- c. An entity substantially controlled through entities incorporated, established, or registered in such a country; or
- d. An entity whose beneficial owner is situated in such a country; or
- e. An Indian (or other) agent of such an entity; or
- f. A natural person who is a citizen of such a country; or
- g. A consortium or joint venture where any member of the consortium or joint venture falls under any of the above

IV. The beneficial owner for the purpose of (III) above will be as under:

- 1. In case of a company or Limited Liability Partnership, the beneficial owner is the natural person(s), who, whether acting alone or together, or through one or more juridical person, has a controlling ownership interest or who exercises control through other means.

Explanation-

- a. "Controlling ownership interest" means ownership of, or entitlement to, more than twenty-five per cent of shares or capital or profits of the company.
- b. "Control" shall include the right to appoint a majority of the directors or to control the management or policy decisions, including by virtue of their shareholding or management rights or shareholders agreements or voting agreements.
- 2. In the case of a partnership firm, the beneficial owner is the natural person(s) who, whether acting alone or together, or through one or more juridical person, has ownership of entitlement to more than fifteen percent of capital or profits of the partnership.
- 3. In case of an unincorporated association or body of individuals, the beneficial owner is the natural person(s), who, whether acting alone or together, or through one or more juridical person, has ownership of or entitlement to more than fifteen percent of the property or capital or profits of such association or body of individuals.
- 4. Where no natural person is identified under (1) or (2) or (3) above, the beneficial owner is the relevant natural person who holds the position of senior managing official.
- 5. In case of a trust, the identification of beneficial owner(s) shall include identification of the author of the trust, the trustee, the beneficiaries with fifteen percent or more interest in the trust and any other natural person exercising ultimate effective control over the trust through a chain of control or ownership.

V. An Agent is a person employed to do any act for another, or to represent another in dealings with third person.

[Note: i. A person who procures and supplies finished goods from an entity from a country which shares a land border with India will, regardless of the nature of his legal or commercial relationship with the producer of the goods, be deemed to be an Agent.

ii. However, a bidder who only procures raw material, components etc. from an entity from a country which shares a land border with India and then manufactures or converts them into other goods will not be treated as agent.]

- VI. In case of tenders for Works contracts, including Turnkey contracts, The successful bidder shall not be allowed to sub-contract works to any contractor from a country which shares a land border with India unless such contractor is registered with the Competent Authority .
- VII. The registration shall be valid at the time of submission of bid and at the time of acceptance of bid.
- VIII. If the bidder was validly registered at the time of acceptance / placement of order, registration shall not be a relevant consideration during contract execution.
- As per the Ministry of Commerce and Industry Order No. P-45021/2/2017-PP(BE-II) dated 16.09.2020 preference shall be given to Make in India products for which it is mandatory for bidders to declare Country of Origin of goods and percentage of Local contents in the product.

Definitions:

“Local Content” means the amount of value added in India which shall, unless otherwise prescribed by the Nodal Ministry, be the total value of the item procured (excluding net domestic indirect taxes) minus the value of imported content in the item (including all customs duties) as a proportion of the total value, in percent.

“Class-I local supplier” means a supplier or service provider, whose goods, services or works offered for procurement, has local content to or more than 50%, as defined under this order.

“Class-II local supplier” means a supplier or service provider, whose goods, services or works offered for procurement, has local content more than 20% but less than 50%, as defined under this order.

“Margin of purchase preference” means the maximum extent to which the price quoted by a Class-I local supplier may be above the L1 for the purpose of purchase preference. (shall be 20%)

Purchase Preference:

- (a) Subject to the provisions of this Order and to any specific instructions issued by the Nodal Ministry or in pursuance of this Order, purchase preference shall be given to 'Class-I local supplier' in procurements undertaken by procuring entities in the manner specified here under.
- (b) In the procurements of goods or works, which are covered by para 3(b) above and which are divisible in nature, the Class-I local supplier' shall get purchase preference over 'Class-II local supplier' as well as 'non-local supplier', as per following procedure:
- i. Among all qualified bids, the lowest bid will be termed as L1. If L1 is Class local supplier', the contract for full quantity will be awarded to L1.
 - ii. If L1 bid is not a 'Class-I local supplier', 50% of the order quantity shall be awarded to L1. Thereafter, the lowest bidder among the 'Class-I local supplier' will be invited to match the L1 price for the remaining 50% quantity subject to the Class-I local supplier's quoted price falling within the margin of purchase preference, and contract for that quantity shall be awarded to such 'Class-I local supplier' subject to matching the L1 price. In case such lowest eligible 'Class-I

local supplier' fails to match the L1 price or accepts less than the offered quantity, the next higher 'Class-I local supplier' within the margin of purchase preference shall be invited to match the L1 price for remaining quantity and so on, and contract shall be awarded accordingly. In case some quantity is still left uncovered on Class-I local suppliers, then such balance quantity may also be ordered on the L1 bidder.

- (c) In the procurements of goods or works, which are covered by para 3(b) above and which are not divisible in nature, and in procurement of services where the bid is evaluated on price alone, the 'Class-I local supplier' shall get purchase preference over 'Class-II local supplier' as well as 'non-local supplier', as per following procedure:
- i. Among all qualified bids, the lowest bid will be termed as L1. If L1 is 'Class-I local supplier', the contract will be awarded to L1.
 - ii. If L1 is not 'Class-I local supplier', the lowest bidder among the 'Class-I local supplier', will be invited to match the L1 price subject to Class-I local supplier's quoted price falling within the margin of purchase preference, and the contract shall be awarded to such 'Class-I local supplier' subject to matching the L1 price.
 - iii. In case such lowest eligible 'Class-I local supplier' fails to match the L1 price, the 'Class-I local supplier' with the next higher bid within the margin of purchase preference shall be invited to match the L1 price and so on and contract shall be awarded accordingly. In case none of the 'Class-I local supplier' within the margin of purchase preference matches the L1 price, the contract may be awarded to the L1 bidder.
- (d) "Class-II local supplier" will not get purchase preference in any procurement undertaken by procuring entities.



(A)

COMMERCIAL TERMS AND CONDITIONS

1. DEFINITIONS

These Commercial Terms and Conditions shall constitute the General Conditions of Contract,

where no separate contract is signed with the selected Bidder(s), and, the Bidders by putting their signature and stamp on each page of this Section V are binding themselves to these Terms and Conditions. In the Commercial Terms and Conditions as defined below, words and expressions shall have the following meanings assigned to them:

- a. "Contract" means the agreement of the Parties relating to the procurement of Goods and / or the IITK Purchase Order (PO), and all attachments incorporated by reference, which shall form an integral part of the Contract. In the event of any discrepancy, the documents to prevail shall be given precedence in the following order: (i) the Contract (where separately signed), (ii) the IITK Purchase Order, (iii) its attachments, and (iv) these Commercial Terms and Conditions;
- b. "Contractor" means the person or entity named in the 'CONTRACTOR' named field of the IITK Purchase Order and any agreed in writing by the IITK legal successor(s) in title;
- c. "Day" means any calendar day;
- d. "Delivery Date" means the latest possible date by which the Goods shall be delivered by the Contractor to the IITK, as specified in the 'DELIVERY DATE' named field of the IITK Purchase Order;
- e. "Force Majeure" shall mean any unforeseeable exceptional situation or event beyond the Parties' control which prevents either of them from fulfilling any of their obligations under the Contract, was not attributable to error or negligence on their part (or of their partners, contractors, agents or employees), and could not have been avoided by the exercise of due diligence. Defects in equipment or material or delays in making them available, labour disputes, strikes or financial problems cannot be invoked as Force Majeure by the defaulting Party. Neither of the Parties shall be held liable for breach of its obligations under the Contract if it is prevented from fulfilling them by Force Majeure. The Party invoking Force Majeure shall notify the other without delay, stating the nature, likely duration and foreseeable effect, and take any measure to minimise possible damage;
- f. "Goods" means all of the goods to be supplied to the IITK by the Contractor under the Contract;
- g. "IITK" means the Indian Institute of Technology Kanpur;
- h. "IITK Purchase Order" means the IITK's official Purchase Order document;
 - (i) "Party" means the IITK or the Contractor and "Parties" means the IITK and the Contractor; and
 - (ii) "Place(s) of Delivery" means the location(s) or place(s) where the Goods are to be delivered, as specified in the 'SHIP TO' named field of the IITK Purchase Order.

2. CONCLUSION OF THE CONTRACT

- 2.1.** The Contract is made between the IITK and the Contractor. The Contractor is engaged as an independent contractor for the sole purpose of delivering the Goods.
- 2.2.** The Contract shall be concluded upon the Contractor duly following the countersigning procedure as stated in the IITK Letter of Intent (LOI).

3. FUNDING

This Contract shall become and remain effective only on the condition that an official Purchase Order is issued by IITK following the conclusion of tender exercise. In the event this is not or no longer shall the case, the IITK without unreasonable delay notify the Contractor thereof.

Any continuation of the Contractor's performance under this Contract after being notified by the IITK shall be at the Contractor's risk and expense.

4. DELIVERY AND TAKE-OVER OF GOODS

The Contractor shall deliver the Goods at the Place(s) of Delivery. On behalf of the IITK, a duly authorised representative(s), shall take-over the Goods upon delivery. Take-over of the Goods by the IITK shall not be deemed acceptance of the Goods by the IITK. The time of delivery as specified in the Contract / PO shall be strictly adhered to, and time shall be of the essence.

5. QUALITY OF GOODS

- 5.1.** The Contractor shall deliver Goods that are:
 - a.** of the quality, quantity and description as required by the Contract / PO; and
 - b.** free from any right or claim of a third party, including rights based on industrial property or other intellectual property.
- 5.2.** Should the Goods be of the type "homogeneously defined" or disposable, the Contractor shall provide a sample and undertake, certify, and guarantee that all Goods delivered shall be of the same quality and characteristics as the sample(s) provided.

6. INSPECTION AND ACCEPTANCE

- 6.1.** The duly authorised representative(s) of the IITK shall have the right, before payment, to inspect the Goods either at the Contractor's stores, during manufacture, at the ports and/or in places of shipment, or at the Place(s) of Delivery. The Contractor shall provide all facilities for such inspection. The IITK may issue a written waiver of inspection. Any inspection carried out by representative(s) of the IITK or any waiver thereof shall be without prejudice to other provisions of the Contract concerning obligations assumed by the Contractor, including specifications of the Goods.
- 6.2.** Upon delivery and inspection of the Goods, the IITK shall inspect the goods as soon as possible and complete the Goods Receiving Document. Should any Goods fail to conform to the technical specifications, codes and standards under the Contract, the IITK may reject the Goods. The Contractor shall, at no cost to the IITK, replace the rejected Goods or, alternatively, rectify the non-conformity.
- 6.3.** In the case of Goods ordered on the basis of specifications or samples, the IITK shall have the right to reject the Goods or any part thereof and terminate the Contract if the Goods do not conform to the specifications and/or samples. Nothing in this clause shall in any way release the Contractor from any warranty or other obligations under the Contract.

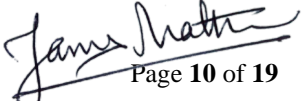
Page 10 of 19

7. SHIPPING AND INSURANCE

For overseas orders, shipping arrangements shall be co-ordinated by IITK. Original shipping documents including the packing list shall be airtailed/emailed by the Contractor to the (Deputy Registrar (S&P), IIT, Kanpur - 208 016, UP, India).

8. OBSERVANCE OF LAW AND EXPORT LICENCES

The Contractor shall comply with all laws, ordinance, rules and regulations bearing upon the performance of its obligations under the terms of the Contract. If an export licence or any other governmental authorisation is required for the Goods, it shall be the obligation of the Contractor to obtain such licence or governmental authorisation. In the event of the Contractor's failure to obtain such licence or authorisation within a reasonable time, the IITK may immediately terminate the Contract. Where the award procedure or execution of the Contract is vitiated by substantial errors or irregularities or by fraud, the IITK shall suspend execution of the Contract.

Where such errors, irregularities or fraud are attributable to the Contractor, the IITK may also refuse to make payments or may recover monies already paid, in proportion to the seriousness of the errors, irregularities or fraud. The purpose of suspending the Contract shall be to verify whether presumed substantial errors and irregularities or fraud have actually occurred. If they are not confirmed, execution of the Contract shall resume as soon as possible. A substantial error or irregularity shall be any infringement of a contract or regulatory provision of India, resulting from an act or an omission that causes or might cause a financial loss.

9. PRICE

The price of the Goods shall be as stated in the Purchase Order and may not be increased.

10. PAYMENT

10.1. Unless otherwise stipulated in the Purchase Order, the IITK shall make payment within thirty (30) Days of the later of:

- a. Successful delivery of the goods to IITK as confirmed by the consignee (Assistant Registrar, Store & Purchase, IIT-Kanpur), endorsed by the indenter and approved by the indenters' Head of Department / Section;
- b. Receipt of customary shipping documents and any other documents specified in the Contract; and (c) Receipt of the original invoice issued by the Contractor.

10.2. All invoices shall be in original and shall contain the IITK Purchase Order number, and a description, the quantities, unit and total price(s) of the Goods delivered. The currency of invoice and payment shall be as specified in the Purchase Order. Unless otherwise authorised by the IITK, a separate invoice shall be submitted for each shipment under the Contract / PO. Subject to Clause 11 below ('Tax Exemption'), if applicable, the GST amount shall be separately identified in the invoice.

10.3. Payments shall be made in the currency stated in the Contract / PO, on the basis of the equivalent value of INR on the day of payment and paid directly into the nominated bank account.

10.4. The IITK shall not pay any charge for late payments.

11. TAX EXEMPTION

The Contractor's price shall reflect any tax exemption to which the IITK is entitled. If it is subsequently determined that any taxes that have been included in the price are

Page 11 of 19

not required to be paid or if, having been paid, any such taxes are subject to refunding, the IITK shall deduct the amount from the Contract price. Payment of such adjusted amount shall constitute full payment by the IITK. In the event that any taxing authority refuses to recognize the IITK's exemption from taxes, the Contractor shall immediately consult with the IITK to determine a mutually acceptable procedure for settling the applicable amount.

12. WARRANTY

- 12.1.** The Contractor warrants that the Goods furnished under the Contract conform to the technical specifications, description and standards specified in the Contract, and are new and unused, and free from defects in design, workmanship and/or materials.
- 12.2.** The Contractor shall provide a warranty for the Goods for a period of one year from the date of acceptance of the Goods by the IITK, unless the standard manufacturer's warranty period is longer in which case the longer period shall apply.
- 12.3.** In the case of "homogeneously defined" or disposable goods, should any portion of the Goods, at any time, not comply with clause 5.1 or 5.2 herein or otherwise prove to be defective, the Contractor shall, upon written notification from the IITK, replace that portion of the Goods and bear all costs associated with the replacement of same.

13. PACKING

- 13.1.** The Goods shall be packed and marked in a proper manner and in accordance with the Contract and any statutory requirements and any requirements of the carrier(s). In particular, the Goods shall be marked with the IITK Purchase Order number and the net, gross and tare weights, the name of the contents shall be clearly marked on each container and all containers of hazardous goods (and all documents relating thereto) shall bear prominent and adequate warnings.
- 13.2.** The Contractor shall provide such packing of the Goods as is required to prevent their damage or deterioration during transit to their final destination. The packing shall be sufficient to withstand, without limitation, rough handling during transit. Packing case size and weights shall take into consideration, where appropriate, the remoteness of the final destination and the absence of appropriate handling facilities at all points in transit.
- 13.3.** All packaging materials shall be non-returnable.

14. DEFAULT AND DAMAGES

- 14.1.** If due to reasons attributable to the Contractor, the Contractor fails or refuses to:
 - a.** deliver any or all of the Goods under the Purchase Order;
 - b.** comply with any or all of the terms and conditions set out in the Purchase Order;or
 - c.** deliver any or all of the Goods under the Purchase Order on or before the Delivery Date; the IITK may hold the Contractor in default under the Purchase Order.
- 14.2.** When the Contractor is thus in default, the IITK may, by written notice to the Contractor, immediately terminate the Purchase Order in whole or in such part or parts thereof in respect of which the Contractor is in default.
- 14.3.** Alternatively, to clause 14 above when the Contractor is thus in default, the IITK may, at its own discretion, set a reasonable period of time for the Contractor to remedy its default. Any new Delivery Date shall be specified in a written amendment to the Purchase Order, duly countersigned by the Contractor.

- 14.4. The IITK may, at its discretion, impose penalties upon the Contractor calculated in accordance with clause 15 for each Day the Contractor is late in delivering the Goods past the Delivery Date initially specified in the Purchase Order.
- 14.5. If the Contractor does not remedy its default within the period of time accorded under clause 16, the IITK may, by written notice to the Contractor, terminate the Purchase Order with immediate effect.
- 14.6. Upon any termination of the Purchase Order, in whole or such part(s) thereof in respect of which the Contractor is in default, the IITK may engage another contractor to deliver the Goods and recover any difference in price and any additional costs from the Contractor.
- 14.7. The Contractor shall indemnify the IITK for all losses, charges, costs and expenses, which the IITK may suffer or incur as a result the Contractor's default, including those resulting from engaging another contractor pursuant to this clause 14.

15. PENALTIES

If, in accordance with clause 15, the IITK imposes penalties on the Contractor, such penalties shall amount to One percent (1%) of the total Purchase Order price for each week following the initial Delivery Date specified in the Purchase Order but shall not amount to more than Ten percent (10%) of the total Purchase Order value. The penalties for the delay may be deducted by IITK from any sum(s) due, or to become due, by the IITK to the Contractor.

16. DELAY NOT ATTRIBUTABLE TO THE CONTRACTOR

If the Contractor is delayed at any time in the delivery of the Goods or fulfilment of any other of the Contractor's obligations by any act or omission of the IITK, or by any of its officials, or by any separate contractor(s) contracted by the IITK, or by changes ordered in the type and/or quantity of the ordered Goods, or the Place(s) of Delivery, or any causes beyond the Contractor's reasonable control, or by any other cause, which the IITK determines may reasonably justify the delay, the Delivery Date of the Goods, or fulfilment of any other of the Contractor's applicable obligations shall be extended for such reasonable period of time as the IITK and the Contractor mutually determine. The set reasonable period of time and any amended delivery date shall be specified in a written amendment to the Contract / PO, duly countersigned by the Contractor.

17. FORCE MAJEURE

As soon as possible after the occurrence of any event constituting Force Majeure, but no later than three (3) Days, the Contractor shall give notice and full particulars in writing to the IITK of the Force Majeure. If the Contractor is thereby rendered unable, wholly or in part, to meet its obligations under the Contract, the IITK may terminate the Contract / PO with immediate effect by providing written notice to the Contractor.

18. INDEMNITY

- 18.1. The Contractor shall indemnify, hold and save harmless and defend at its own expense the IITK, and all of the foregoing's officials, agents, servants and employees from and against all suits, claims, demands and liability of any nature or kind, including costs and expenses, arising out of acts or omissions of the Contractor or its employees, agents or subcontractors in the performance of the Contract.
- 18.2. Clause 18 shall include, without limitation, claims and liabilities in the nature of workmen's compensation and claims and liabilities arising out of the use of patented inventions or devices.

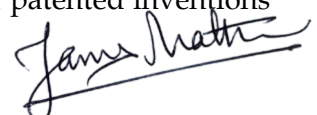

19. ASSIGNMENT

- 19.1.** The Contractor shall not assign, transfer, pledge or make other disposition of the Purchase Order or any part thereof or of any of the Contractor's rights, claims or obligations under the Purchase Order except with the express written consent of the IITK. Any assignment made without such consent shall be void and of no effect.
- 19.2.** The Contractor shall not subcontract any of its obligations under the Contract / PO without the express written consent of the IITK. The IITK may require the Contractor to furnish particulars of the proposed subcontract as the IITK deems necessary.
- 19.3.** The IITK's approval of any subcontracting shall not relieve the Contractor from any liability or obligation under the Contract. In any subcontract, the Contractor agrees to bind the subcontractor by the same terms and conditions by which the Contractor is bound under the Contract / PO.

20. INSOLVENCY AND BANKRUPTCY

- 20.1.** Should the Contractor become insolvent or should control of the Contractor change by virtue of insolvency, the IITK may with immediate effect and without prejudice to any other right or remedy available to it, suspend the performance of the Contractor's obligations or terminate the Purchase Order with immediate effect, by providing the Contractor with written notice thereof.
- 20.2.** Should the Contractor be adjudged bankrupt, or should the Contractor make a general assignment for the benefit of its creditors, or should a receiver be appointed on account of the Contractor's insolvency, the IITK may, without prejudice to any other right or remedy available to it, terminate the Purchase Order with immediate effect by providing the Contractor with written notice thereof.

21. TERMINATION

- 21.1.** The IITK shall have the right to terminate the Purchase Order or any of the provisions thereof at any time by serving a three days' notice to the Contractor.

22. WAIVER

A waiver of any breach of or default under the Contract / PO shall not constitute a waiver of any other breach or default and shall not affect the other terms of the Contract / PO. The rights and remedies provided by the Purchase Order are cumulative and are not exclusive of any other rights or remedies.

23. ADVERTISING

The Contractor shall not advertise or otherwise make public the fact that it is a contractor to the IITK. The Contractor shall not in any way use the name, emblem, logo, official seal, or any abbreviation of the IITK.

24. DISCRETION AND CONFIDENTIALITY

The Contractor is required to exercise the utmost discretion in all matters relating to the Contract / Purchase Order. Unless required in connection with the performance of the Purchase Order or expressly authorised in writing by the IITK, the Contractor shall not disclose at any time to any third party any information which has not been made public and which is known to the Contractor by reason of its association with the IITK. The Contractor shall not, at any time, use such information to any private advantage. These obligations do not lapse upon any completion, expiration, cancellation or termination of the Contract / PO.

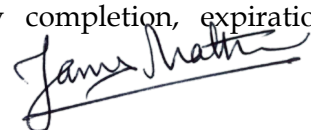

25. NOTICES

Any notice given in connection with the Contract shall be given in English and in writing and shall be deemed to be validly given if sent by registered mail or by fax or by email to the other Party at the following:

- a. for the IITK: the contact details set out in the 'IITK BUYER' name field of the Purchase Order; and
- b. for the Contractor: the contact details set out in the 'CONTRACTOR' named field of the IITK Contract/Purchase Order.

26. STAFF MEMBERS NOT TO BENEFIT

The Contractor shall not grant to any official of the IITK any direct or indirect benefit or preferential treatment on the basis of the Purchase Order or the award thereof. Any breach of this provision shall constitute a fundamental breach of the Purchase Order.

27. GOVERNING LAW

The Contract shall be governed by and construed in accordance with the substantive laws of the Republic of India.

28. SETTLEMENT OF DISPUTES

- 28.1. The Parties shall use their best efforts to negotiate and amicably settle any disputes, controversies or claims arising out of, or in connection with, the Contract / Purchase Order or its interpretation.
- 28.2. If the Parties fail to settle the dispute amicably within thirty (30) Days of commencement of the negotiations, the dispute shall be settled through arbitration. One (1) sole arbitrator shall be appointed by the Director of IITK who shall have full powers to make final and binding decisions subject to prevailing laws of India. The appointing authority shall be the Director of IITK. The place of arbitration shall be Kanpur and the language used in the arbitration proceedings shall be English.

29. PRIVILEGES AND IMMUNITIES

No provision of the Contract / Purchase Order shall be deemed, or interpreted as, a waiver of the privileges and immunities enjoyed by the IITK.

30. AMENDMENTS

No modification, amendment or change to the Contract/Purchase Order, or waiver of any of its provisions, or any additional contractual relationship with the Contractor shall be valid unless approved in the form of a written amendment to the Contract/Purchase Order, signed by a fully authorised representative of each Party.

31. VALIDITY

The invalidity in whole or part of any condition of the Contract / Purchase Order or clause thereof shall not affect the validity of the remainder of such condition or clause.

32. ENTIRE AGREEMENT

The Contract / Purchase Order constitute the entire agreement and understanding of the Parties and supersede any previous agreement, whether orally or in writing, between the Parties relating to the subject matter of the Contract.



33. GOVERNING LANGUAGE

The Contract / Purchase Order shall be executed in the English language which shall be the binding and controlling language for all matters relating to the meaning and interpretation of the Contract / Purchase Order.

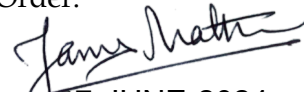
07-JUNE-2024

TENDER ACCEPTANCE LETTER
(To be given on Company Letter Head)

Date: _____

To,
The Officer-In-Charge
Central Stores
IIT Kanpur-208016

Sub: Acceptance of Terms & Conditions of Tender.

Tender Reference No: _____

Name of Tender / Work: -

Dear Sir,

1. I / We have downloaded / obtained the tender document(s) for the above mentioned 'Tender/Work' from the web site(s) namely:

_____ as per your advertisement, given in the above mentioned website(s).

2. I / We hereby certify that I / we have read the entire terms and conditions of the tender documents from Page No. _____ to _____ (including all documents like annexure(s), schedule(s), etc .), which form part of the contract agreement and I / we shall abide hereby by the terms / conditions / clauses contained therein.

3. The corrigendum(s) issued from time to time by your department/ organisation too have also been taken into consideration, while submitting this acceptance letter.

4. I / We hereby unconditionally accept the tender conditions of above mentioned tender document(s) / corrigendum(s) in its totality / entirety.

5. I / We do hereby declare that our Firm has not been blacklisted/ debarred/ terminated/ banned by any Govt. Department/Public sector undertaking.

6. I / We certify that all information furnished by our Firm is true & correct and in the event that the information is found to be incorrect/untrue or found violated, then your department/ organisation shall without giving any notice or reason therefore or summarily reject the bid or terminate the contract, without prejudice to any other rights or remedy including the forfeiture of the full said earnest money deposit absolutely.

Yours Faithfully,
(Signature of the Bidder, with Official Seal)

Declaration for Local Content

**(To be given on Company Letter Head - For tender value below Rs.10 Crores)
(To be given by Statutory Auditor/Cost Auditor/Cost Accountant/CA for tender value
above Rs.10 Crores)**

Date: _____

To,
The Officer-In-Charge
Central Stores
IIT Kanpur-208016

Sub: Declaration of Local content

Tender Reference No: _____

Name of Tender / Work: - _____

1. Country of Origin of Goods being offered: _____
2. We hereby declare that items offered has ____% local content.
3. Details of location(s) at which the local value addition is made: _____

"Local Content" means the amount of value added in India which shall, be the total value of the item being offered minus the value of the imported content in the item (including all customs duties) as a proportion of the total value, in percent.

*"*False declaration will be in breach of Code of Integrity under Rule 175(1)(i)(h) of the General Financial Rules for which a bidder or its successors can be debarred for up to two years as per Rule 151 (iii) of the General Financial Rules along with such other actions as may be permissible under law."*

**Yours Faithfully,
(Signature of the Bidder, with Official Seal)**

Certificate for Tender
(To be given on Company Letter Head)

Date: _____

To,
The Officer-in-charge
Central Stores
IIT Kanpur-208016

Sub: Certificate of compliance as per Rule 144 (xi) GFR's 2017

Tender Reference No: _____

Name of Tender / Work: -

1."I have read the clause regarding restrictions on procurement from a bidder of a country which shares a land border with India; I certify that this bidder is not from such a country or, if from such a country, has been registered with the Competent Authority. I hereby certify that this bidder fulfils all requirements in this regard and is eligible to be considered. [Where applicable, evidence of valid registration by the Competent Authority shall be attached.]"

2. "I have read the clause regarding restrictions on procurement from a bidder of a country which shares a land border with India and on sub-contracting to contractors from such countries; I certify that this bidder is not from such a country or, if from such a country, has been registered with the Competent Authority and will not sub-contract any work to a contractor from such countries unless such contractor is registered with the Competent Authority. I hereby certify that this bidder fulfills all the requirements in this regard and is eligible to be considered. [Where applicable, evidence of valid registration by the Competent Authority shall be attached.]"

Yours Faithfully,
(Signature of the Bidder, with Official Seal)